

SINGLE-PARAMETER THIN-LAYER DRYING EQUATIONS FOR LONG-GRAIN RICE

B. Prakash, T. J. Siebenmorgen

ABSTRACT. *The use of multiple parameters in thin-layer drying equations makes it difficult to compare and quantify the impact of drying air temperature, relative humidity, and other factors on the drying characteristics of an agricultural crop. In this study, two single-parameter equations are proposed to quantify thin-layer drying characteristics of contemporary long-grain rice cultivars grown in the Mid-South U.S. Drying runs were first performed to obtain drying curves for cultivar 'Roy J' under 18 air conditions; several drying equations were evaluated for their fit to each drying curve. The proposed single-parameter equations (modified Page equation and infinite-series diffusion equation) described the experimental drying data very accurately; the root mean square errors in moisture ratio obtained for the modified Page and infinite-series diffusion equations varied in the ranges of 0.2 to 1.4 and 0.3 to 1.5 percentage points, respectively. The dependence of drying air temperature and relative humidity on drying parameters of the modified Page and infinite-series diffusion equations was described by second-order polynomial regression equations. The impact of harvest moisture content on the drying characteristics of rice was observed to be negligible. The validity of the developed single-parameter equations was also evaluated for five other long-grain rice cultivars; for these cultivars, the maximum errors in the moisture ratio prediction using the modified Page and infinite-series diffusion equations were 2.9 and 3.4 percentage points, respectively. This study provides thin-layer drying data for contemporary rice cultivars in the Mid-South U.S. The resulting thin-layer drying equations are expected to improve the accuracy of deep-bed drying models. While the proposed single-parameter equations were tested only for long-grain rice, the methodology presented in this research could be used to develop similar single-parameter thin-layer drying equations for short-grain and medium-grain rice, as well as other agricultural crops. As such, these equations could be readily used in quantifying the impacts of air and rice variables on drying rates.*

Keywords. *Mathematical modeling, Rice, Thin-layer drying.*

Thin-layer drying equations are an important research tool in grain drying. They are used to describe the drying characteristics of grain exposed to given air conditions and thus can be used to compare the impact of air temperature and relative humidity (RH). Furthermore, thin-layer drying equations are an essential component of mathematical models describing drying in deep beds. Lack of thin-layer drying data has been identified as the key factor that affects the accuracy of deep-bed drying models (Brooker et al., 1992; Prakash et al., 2017).

Several thin-layer drying studies have been reported for various rice types (Kachru et al., 1970; Agrawal and Singh, 1977; Verma et al., 1985; Hacıhafızoglu et al., 2008). (In this article, "rice" refers to rough rice or paddy, which is the unhulled form of the crop). However, little information exists for contemporary long-grain cultivars grown in the Mid-South U.S.

Thin-layer drying studies are performed by drying a thin layer of kernels that allows identical drying air conditions

for all kernels. ASABE Standard S448.2 (ASABE, 2014) specifies the maximum layer depth to be three layers of kernels and the minimum air velocity approaching the kernels to be 0.3 m s^{-1} . The thickness of the thin layer could be greater if the air velocity is sufficiently increased (Kucuk et al., 2014). Thin-layer drying data are mathematically expressed by equations relating moisture ratio (MR, decimal) to drying duration (t , min):

$$\text{MR} = \frac{M - M_e}{M_i - M_e} = f(t) \quad (1)$$

where M is the instantaneous moisture content (MC), M_i is the initial MC, and M_e is the equilibrium moisture content (EMC) associated with the drying air temperature and RH conditions, all expressed in decimal form on a dry basis.

The mathematical form of most thin-layer drying equations has been derived from Fick's laws of diffusion (Kucuk et al., 2014). Assuming the shape of a rice kernel to be a sphere, the solution to the Fickian diffusion equation for constant surface concentration is expressed as (Crank, 1975):

$$\text{MR} = \frac{6}{\pi^2} \sum_{i=1}^{\infty} \left[\frac{1}{i^2} \times \exp\left(\frac{-Di^2\pi^2 t}{r^2}\right) \right] \quad (2)$$

where r (m) is the radius of an equivalent sphere, and D ($\text{m}^2 \text{ min}^{-1}$) is the moisture diffusivity within a rice kernel. For

Submitted for review in August 2017 as manuscript number PRS 12555; approved for publication by the Processing Systems Community of ASABE in December 2017.

The authors are **Bhagwati Prakash**, Research Associate, and **Terry J. Siebenmorgen**, Distinguished Professor, Department of Food Science, University of Arkansas, Fayetteville, Arkansas. **Corresponding author:** Terry J. Siebenmorgen, 2650 N. Young Ave., Fayetteville, AR 72704; phone: 479-575-2841; e-mail: tsiebenm@uark.edu.

a given rice cultivar, the radius and diffusivity can be lumped into one drying parameter (k); the resulting expression then becomes:

$$MR = \frac{6}{\pi^2} \sum_{i=1}^{\infty} \left[\frac{1}{i^2} \times \exp(-i^2 \pi^2 kt) \right] \quad (3)$$

Despite having a single, experimentally determined parameter, equation 3 has rarely been used to describe thin-layer drying characteristics of rice. Nevertheless, several drying equations have been developed by truncating the infinite series to the first few terms and introducing additional parameters to improve the fit to experimental data. Table 1 lists some published thin-layer drying equations for rough rice.

The parameters of thin-layer drying equations are determined by minimizing the difference between experimentally measured and equation-predicted MRs. The success of any equation is determined by its ability to accurately describe the drying data over a wide range of drying conditions. For thin-layer drying of rice under a given air condition, the two-parameter Page and four-parameter Midilli equations are commonly reported to be successful (Cnossen et al., 2002; Hacıhafızoglu et al., 2008; Ondier et al., 2010; ASABE, 2014).

It should be noted that thin-layer drying equations do not describe the intra-kernel moisture distribution; another set of mathematical relationships, which are sometimes referred to as single-kernel models, have been developed for such purposes (Steffe and Singh, 1980; Lu and Siebenmorgen, 1992; Prakash and Pan, 2011). The single-kernel models take into account the unique shape, size, and morphology of rice kernels and use moisture and heat transfer equations to describe drying of a single kernel (Prakash and Pan, 2012). While the single-kernel models provide a detailed description of the drying phenomenon, the complexity involved in solving such models precludes their application in deep-bed drying models.

Drying air conditions, typically represented by air temperature and RH, influence thin-layer drying in two ways: by affecting the grain EMC that the grain MC approaches during drying and by raising the grain temperature, which increases the internal moisture movement within kernels. In thin-layer drying equations, the calculation for MR takes into account the grain EMC, while the parameters of the equation typically characterize the internal moisture movement within kernels. The impact of air temperature and RH on the grain EMC is described by moisture isotherm equations; an example for long-grain rice is provided by Ondier et al. (2011).

The parameters of thin-layer drying equations depend upon the grain properties, such as harvest MC, chemical composition, and dimensions, as well as the drying air properties, such as temperature, RH, and velocity (Allen, 1960;

Verma et al., 1985; Prakash et al., 2011). The temperature dependence of the Newton equation parameter k has been expressed by an Arrhenius-type exponential relationship (Henderson, 1974; Verma et al., 1985). However, the temperature or RH dependence of the Page equation parameters has only been reported by Agrawal and Singh (1977). The presence of two interdependent parameters in the Page equation makes it difficult to compare and quantify the impact of air temperature, RH, or other factors, such as different cultivars or types of rice, on the drying parameters (Jayas et al., 1991; Cnossen et al., 2002). This inability severely restricts the usefulness of the Page and other multi-parameter equations in the development of deep-bed drying models. Therefore, two single-parameter equations, the infinite-series diffusion equation and a modified form of the Page equation, were proposed in this study to describe thin-layer drying of rice.

The goal of this study was to quantify the thin-layer drying characteristics of contemporary, long-grain rice cultivars grown in the Mid-South U.S. using single-parameter equations. While multiple parameters have been used for describing the drying characteristics of grains, the development of single-parameter equations is deemed advantageous for comparing the impacts of air and rice properties on drying characteristics. To accomplish this goal, the following objectives were selected:

1. Measure the thin-layer drying characteristics of rice using a wide range of air temperature and RH conditions.
2. Determine parameters of the thin-layer drying equations for each air condition.
3. Describe the temperature and RH dependence of the equation parameters.
4. Determine the impact of harvest MC of rice on the equation parameters.
5. Determine the validity of the developed equations for a range of popular long-grain rice cultivars.

MATERIALS AND METHODS

RICE SAMPLES

Several long-grain rice cultivars, commonly grown in the Mid-South U.S., were used in the thin-layer drying experiments (table 2). The rice lots included three pure-line and three hybrid cultivars. The harvested rice was cleaned using a dockage tester (XT4, Carter-Day, Minneapolis, Minn.) to remove foreign materials and unfilled kernels and then stored at approximately 4°C in sealed containers prior to the drying experiments.

LABORATORY DRYER

Drying air at a desired temperature and RH was produced by a 0.91 m³ controlled-environment chamber (ESPEC,

Table 1. Commonly used thin-layer drying equations for rice.

Equation Name	Description ^[a]	Parameters	Reference
Newton	MR = exp(-kt)	k	Hacıhafızoglu et al. (2008)
Two-term diffusion	MR = A × exp(-k ₁ t) + B × exp(-k ₂ t)	k_1, k_2, A, B	Henderson (1974)
Page	MR = exp(-kt ⁿ)	k, n	Page (1949)
Midilli	MR = A × exp(-kt ⁿ) + Bt	k, n, A, B	Midilli et al. (2002)

^[a] MR is the moisture ratio (eq. 1) expressed in decimal form, t is the drying duration expressed in any time unit, and $A, B, n, k_1,$ and k_2 are experimentally determined parameters.

Table 2. Harvest information for rice lots.

Cultivar	Harvest MC (% w.b.)	Harvest Location	Harvest Year
Pure-line			
Roy J	17.1	Keiser, Arkansas	2016
Roy J	21.3	Keiser, Arkansas	2016
Roy J	18.4	Keiser, Arkansas	2015
CL152	19.5	Keiser, Arkansas	2015
LaKast	17.4	Keiser, Arkansas	2015
Hybrid			
XP753	14.0	Keiser, Arkansas	2016
XP753	16.3	Keiser, Arkansas	2016
XP753	17.9	Keiser, Arkansas	2016
CL XL745	19.4	Southeast Missouri	2015
XP753	18.7	Pocahontas, Arkansas	2015
XP760	19.9	Pocahontas, Arkansas	2015

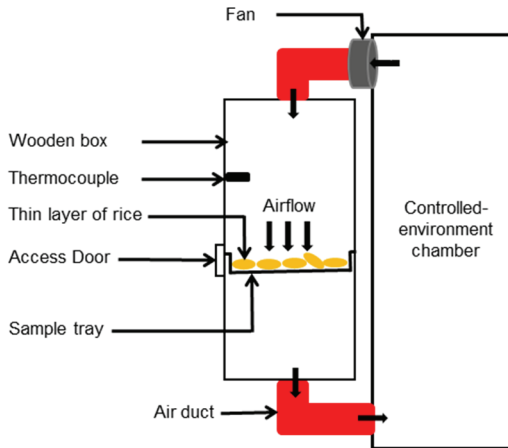

Figure 1. Schematic of thin-layer grain drying apparatus.

Hudsonville, Mich.). An inline centrifugal fan (FG-4, Fantech, Lenexa, Kans.) was mounted outside the chamber to avoid high-temperature exposure. The fan suctioned air from the chamber and forced it through the kernels on a sample tray (fig. 1). After passing through the rice kernels, the air returned to the chamber through an air duct. The sample tray was housed in a wooden box with an access door that allowed removal of the sample tray for weighing on a scale (SPX 1202, Ohaus, Parsippany, N.J.). The base of the sample tray was metallic, wire-meshed, and square in shape with 25 mm sides. A K-type thermocouple was placed in the drying airstream above the sample tray to verify the air temperature.

DRYING EXPERIMENTS

Prior to the drying runs, rice was taken from the refrigerated storage and equilibrated to room temperature (~21°C) in a closed plastic bag. The initial rice MC was determined by drying duplicate 15 g subsamples in a convection oven, which was operated at 130°C for 24 h (Jindal and Siebenmorgen, 1987).

A 200 g sample of rice was placed in a uniform thin layer (one or two kernels deep) on the sample tray. During the drying process, the sample tray was weighed at durations of 2, 5, 10, 15, 20, 30, 40, 50, and 60 min. Extending the drying experiment for a longer period was considered unnecessary because the drying duration typically used in industrial rice dryers in the Mid-South U.S. is between 20 and 30 min. The

duration required to weigh each sample was less than 10 s; preliminary experiments confirmed that the sample weighing procedure did not measurably affect the reported drying data.

Thin-layer drying runs were performed for cultivar ‘Roy J’ using 18 drying air conditions, with six air temperatures from 20°C to 60°C and air RH varied from 12% to 72% (see the Appendix). The selected air conditions represent a wide range of air conditions that have been observed in typical on-farm and industrial rice drying operations. These drying runs were used to determine the parameters of the drying equations. Additional drying runs were conducted to evaluate the impact of harvest MC on the equation parameters and to determine the validity of the developed equations across a range of popular long-grain rice cultivars; drying air of 45°C and 30% RH was used in these runs. For all drying experiments, the air velocity approaching the rice was approximately 0.9 ± 0.1 m s⁻¹, which was measured with a vane-type anemometer (HHF141, Omega Engineering, Inc., Norwalk, Conn.). At each drying condition, two drying runs were generally performed; the difference in MRs obtained between the duplicate runs varied on average by less than 1.0 percentage point. The average MRs obtained from the drying runs were used to determine the parameters of the drying equations.

DEVELOPMENT OF THIN-LAYER DRYING EQUATIONS

For each drying run, the MC of rice at each drying duration was calculated using the initial MC and the sample mass at that duration. The EMC of the rice (M_e , decimal form on a dry basis) corresponding to a specific drying air condition was determined using the modified Chung-Pfost equation with parameters obtained from Ondier et al. (2011):

$$M_e = \frac{1}{0.2316} \times \ln \left[\frac{-511.7649}{(T + 22.1226) \times \ln(rh)} \right] \quad (4)$$

where T (°C) is the temperature and rh (decimal form) is the relative humidity of the drying air. Once the MCs and EMC were known, the MR at each drying duration was determined using equation 1. To graphically compare the drying results from the different drying experiments, MR was plotted versus drying duration, as is common in the thin-layer drying literature (Henderson and Pabis, 1961; Agrawal and Singh, 1977; Hacıhafızoglu et al., 2008).

Three equations were initially used to fit the thin-layer drying data: Newton (table 1), Page (table 1), and infinite-series diffusion (eq. 3). Because the infinite series rapidly converges, a limited number of series terms was sufficient to calculate the series sum. For all tested rice drying conditions, the contribution of the first 30 terms of the infinite series was observed to contribute more than 99.9% of the series sum; therefore, the number of terms was selected to be 30. With an increase in the drying duration or greater values of the drying parameter k , the series converges much sooner. Therefore, a smaller value of terms would be sufficient for longer drying durations or for other grains that dry faster.

Parameters of the drying equations were obtained by minimizing the root mean square error (RMSE) by the GRG

nonlinear method (Solver tool in Microsoft Excel 2013, Microsoft Corp., Redmond, Wash.). The RMSE quantifies the goodness of fit between the equation and experimental data and is defined as:

$$\text{RMSE} = \sqrt{\frac{\sum_{n=1}^N (\text{MR}_{\text{eq}} - \text{MR}_{\text{ex}})^2}{N}} \quad (5)$$

where MR (%) is the moisture ratio, and N is the number of duration data points for each drying run. The subscripts *eq* and *ex* indicate whether the MR is determined from the equation or experiments, respectively.

Once parameters for the thin-layer drying equations were determined, the RMSE values were used to compare the equations and identify which equations were most suitable under the tested drying conditions. Thereafter, multi-linear regression was performed to describe the air temperature and RH dependence of parameters of the drying equations (Data Analysis tool in Microsoft Excel 2013, Microsoft Corp., Redmond, Wash.); the stepwise model selection method was employed with adjusted R^2 as the principal criterion in the model.

Because the Page equation has two interdependent parameters, separate multi-linear regression for the equation parameters was not appropriate. To overcome this limitation, the drying parameter n of the Page equation was allotted a fixed value for all drying conditions; such a modification allowed the Page equation to become a single-parameter equation and enabled the parameter k to be expressed as a function of drying air temperature and RH using multi-linear regression. The fixed value of n for the modified Page equation was determined by averaging the n values that were determined earlier by the original Page equation and are listed in the Appendix. It should also be noted that the drying parameter k of the modified Page equation is different from the k of the original Page equation.

RESULTS AND DISCUSSION

DRYING CURVES

Thin-layer drying curves for rice cultivar ‘Roy J’ under 18 drying air conditions are shown in figure 2. These curves show that MR was affected by both air temperature and RH. Drying rates, indicated by the slopes of the drying curves, increased with an increase in drying air temperature. The impact of drying air temperature on drying rate is well known and has been extensively reported (Henderson and Pabis, 1961; Verma et al., 1985; Hacıhafizoglu et al., 2008). When drying air RH is kept constant, the rice temperature increases with an increase in drying air temperature, which then increases the mobility of water molecules within the kernels, thereby allowing more rapid drying.

In general, drying rates increased with a decrease in drying air RH (fig. 2). An exception to this trend was observed at 60°C (fig. 2f), where the drying rate at 30% RH was slightly less than at 12% RH. Cnossen et al. (2002) reported a similar observation during drying of a long-grain rice cultivar ‘Cypress’ at 60°C in that the drying rate increased with decreasing air RH from 52% to 27%; however, a further de-

crease in RH to 20% resulted in a lesser drying rate. This trend was explained by Cnossen et al. (2002) based on the glass transition phenomenon, which stipulates lesser drying rates for rice kernels in the “glassy” material state than in the “rubbery” state (Cnossen and Siebenmorgen, 2000).

The drying curves at 30% RH are very close to those at 50% RH; however, air at 70% RH or greater typically produced much slower drying of rice kernels (fig. 2). These results are in agreement with Agrawal and Singh (1977), who dried short-grain rice at 51°C and observed similar drying behavior in the 19% to 85% RH range; the drying curves for 19%, 25%, and 45% were similar but distinct from the drying curves at higher RH conditions of 65% and 85%. Prakash et al. (2011) also observed similar trends for drying of rough rice kernels at 25°C. In an apparent contrast, Verma et al. (1985) concluded that the impact of RH on drying parameters (and therefore drying rates) was so small that these parameters could be considered independent of air RH; however, such observations may have been due to the narrow range of RH conditions tested at each drying air temperature.

The observed impact of drying air RH on drying curves (fig. 2) appears to violate classical diffusion theory, according to which the drying curves, when expressed as MR versus drying duration, should only depend on grain properties, such as moisture diffusivity and kernel dimensions, and not on the air RH. Mathematically, the factors characterizing the drying curves are represented on the right side of the solution of the diffusion equation, such as in equation 2; the air RH that affects the EMC of rice kernels is embedded in the dimensionless expression MR on the left side of the solution. The violation of classical diffusion theory by the drying curves in figure 2 could be explained based on two factors: either the prediction of EMC at higher RH conditions had errors, or the diffusion theory does not adequately describe the drying of rice kernels.

The EMCs used in this research are based on the modified Chung-Pfost equation that used adsorption EMC data for RH conditions closer to 70% and desorption EMCs for the remaining RH conditions. The desorption EMCs, which are more relevant for drying of kernels, are known to be slightly greater than the adsorption EMCs (Banaszek and Siebenmorgen, 1990; Bingol et al., 2012). Therefore, the differences in drying curves at any given air temperature in figure 2 are expected to become slightly less once actual desorption EMC values are used for development of the drying curves under high air RH conditions; unfortunately, such desorption EMCs are not available for the Mid-South long-grain rice cultivars.

The diffusion theory used for developing equation 2 assumes that the diffusivity is independent of MC and the moisture movement within the kernel is isotropic. However, the moisture diffusivity of rice kernels has been observed to vary with MC (Prakash et al., 2011). Furthermore, magnetic resonance imaging of *in situ* drying of rice kernels has shown that the moisture movement within rice kernels is not isotropic (Prakash, 2011). While diffusion theory may not entirely describe the moisture movement within rice kernels, the diffusion equations could still be used to characterize thin-layer drying of rice by making diffusivity (or the drying parameter k in eq. 3) vary with the drying air RH.

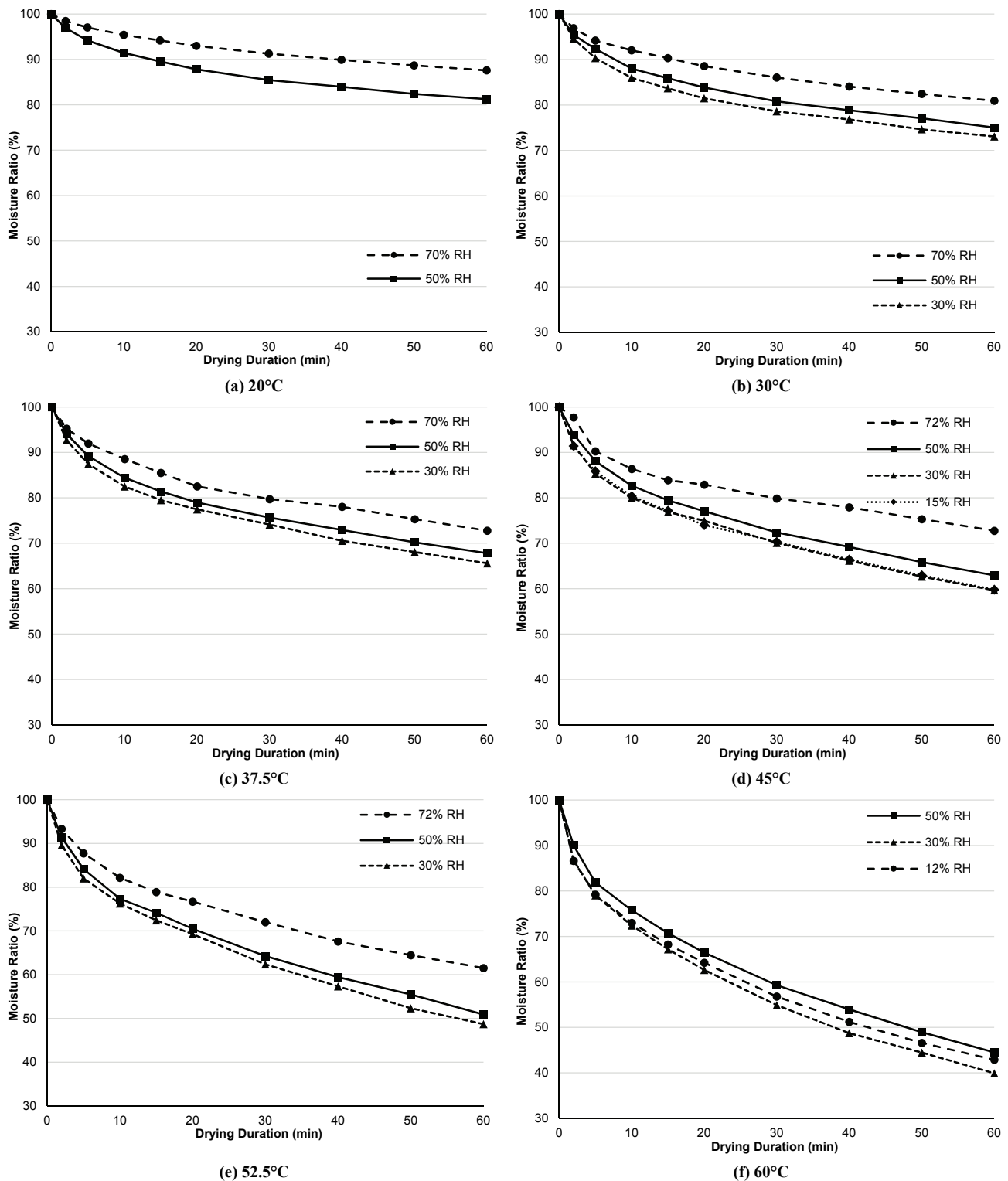

Figure 2. Rough rice drying curves under various drying air RH conditions at six drying air temperatures (20°C, 30°C, 37.5°C, 45°C, 52.5°C, and 60°C) for long-grain cultivar ‘Roy J’. Initial MC values for drying runs corresponding to each drying air condition are listed in the Appendix.

THIN-LAYER DRYING EQUATIONS

For each of the 18 drying air conditions, parameters of the Newton, Page, and infinite-series diffusion equation were determined. Figure 3 illustrates typical performance of the three drying equations in describing experimental data; the Page and infinite-series diffusion equations described the experimental data very accurately, whereas the Newton equa-

tion had a poor fit. The RMSEs of the MRs obtained for the Newton, Page, and infinite-series diffusion equations varied in the range of 1.6 to 8.0, 0.1 to 1.8, and 0.3 to 1.9 percentage points, respectively (see the Appendix). While the infinite-series form of the diffusion equation is rarely reported in the literature, the RMSE values obtained for the Newton and Page equations are comparable to Hacıhafızoglu et al.

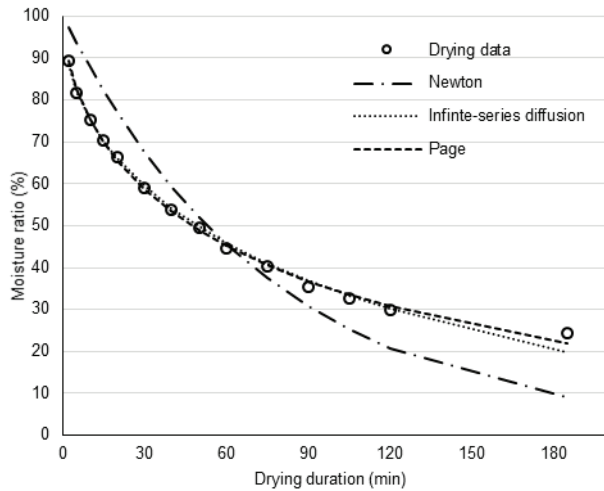

Figure 3. Comparison of rice drying curves obtained by experiment and by three thin-layer drying equations fitted to the experimental data. Air conditions for the drying run were 60°C and 50% RH, and initial moisture content of ‘Roy J’ rice was 18.6% (w.b.).

(2008), who reported RMSE values in the range of 4 to 7 and 0.3 to 0.8 percentage points, respectively, for these two equations. In general, the Page equation fit the experimental data slightly better than the infinite-series diffusion equation; however, the difference between the two equations was negligible for most drying air conditions.

When the infinite-series diffusion equation was truncated to the first few terms, the fit to the experimental data became unsatisfactory. Figure 4 shows the fit of the diffusion equation (eq. 3) when the total number of series terms (N) was varied between 2 and 30. It should be noted that the drying parameter k was determined separately for the diffusion equations corresponding to each N . As expected, with an increase in N , the fit of the diffusion equation improved. However, increasing N beyond 30 did not produce further improvements in the equation’s fit for any of the 18 tested air conditions. These results clearly demonstrate the need for

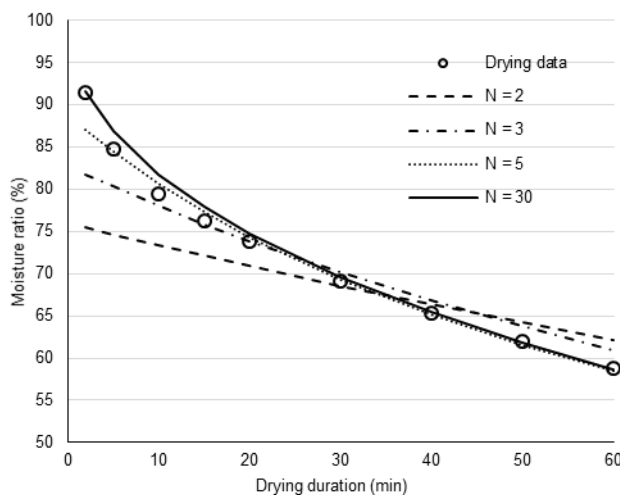

Figure 4. Comparison of rice drying curves obtained by experiment and by the infinite-series diffusion equation (eq. 3) using different number of terms (N) for calculating the series sum. Air conditions for the drying run were 45°C and 30% RH, and initial moisture content of ‘Roy J’ rice was 18.8% (w.b.).

using a large number of series terms in the infinite-series diffusion equation.

For all 18 drying air conditions investigated in this study, the Page equation parameter n varied between 0.45 and 0.59, with an average value of 0.52. Because the variation in n was small, a modified Page equation was proposed that used a fixed value for n and therefore had just one drying parameter:

$$MR = \exp(-kt^{0.52}) \quad (6)$$

where t (min) is the drying duration, and k is the drying parameter that was obtained by minimizing the RMSEs. It should be noted that the selection of n was strictly based on the drying conditions investigated in this study; other values of n may be found suitable for other rice types. Holding n to a fixed value made the fit of the modified Page equation slightly worse than the original Page equation; however, its fit was still comparable to the infinite-series diffusion equation and better than the Newton equation (see the Appendix). In addition to the parameters of the drying equations, the Appendix also includes the experimental thin-layer data for each drying run, which are deemed useful for future thin-layer drying research.

TEMPERATURE- AND RH-DEPENDENCE OF DRYING PARAMETERS

The temperature- and RH-dependence of the drying parameter k , listed in the Appendix, was only determined for the infinite-series diffusion and modified Page equations, the only two single-parameter equations that produced satisfactory RMSEs. Because the drying parameters of both these equations represented the same experimental drying data, these parameters are correlated to each other. Therefore, trends in the parameter of only one of these equations are discussed.

When the drying air RH was kept constant, the variation in the modified Page equation parameter would be solely due to drying air temperatures, and this relationship was successfully described by second-order polynomial, Arrhenius-type, or exponential equations (fig. 5). In contrast to air temperature, the impact of air RH on the drying parameters was much less (fig. 6). No data fitting was performed to determine the nature of the RH dependence because fewer drying runs were performed at each air temperature. In general, the drying parameter decreased with an increase in air RH.

Multi-linear regression was performed to quantify the temperature- and RH-dependence of the parameters for the modified Page and infinite-series diffusion equations:

$$k_{\text{Modified Page}} = -9.93 \times 10^{-3} + 5.07 \times 10^{-4}(T) + 1.17 \times 10^{-3}(RH) + 2.04 \times 10^{-5}(T^2) - 1.23 \times 10^{-5}(RH^2) - 1.00 \times 10^{-5}(T \times RH) \quad (7)$$

($R^2 = 0.9922$, adjusted $R^2 = 0.9890$, and standard error = 0.0027)

$$k_{\text{Diffusion}} = -4.49 \times 10^{-6} - 5.51 \times 10^{-8}(T) + 2.49 \times 10^{-7}(RH) + 5.45 \times 10^{-9}(T^2) - 1.93 \times 10^{-9}(RH^2) - 2.92 \times 10^{-9}(T \times RH) \quad (8)$$

($R^2 = 0.9877$, adjusted $R^2 = 0.9826$, and standard error = 5.18×10^{-7})

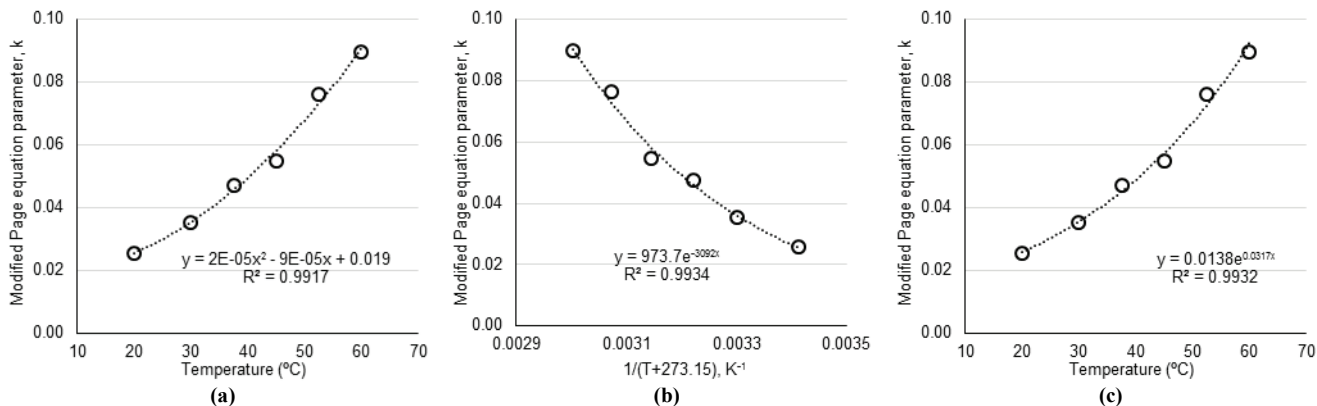

Figure 5. Relationship between the modified Page equation parameter k (eq. 6) and drying air temperature T ($^{\circ}\text{C}$) described using (a) second-order polynomial, (b) Arrhenius type, and (c) exponential equations. Circles represent values of parameters at the six temperatures, and dotted lines show the fit of selected data-fitting equation. Drying air RH for the drying runs was 50%.

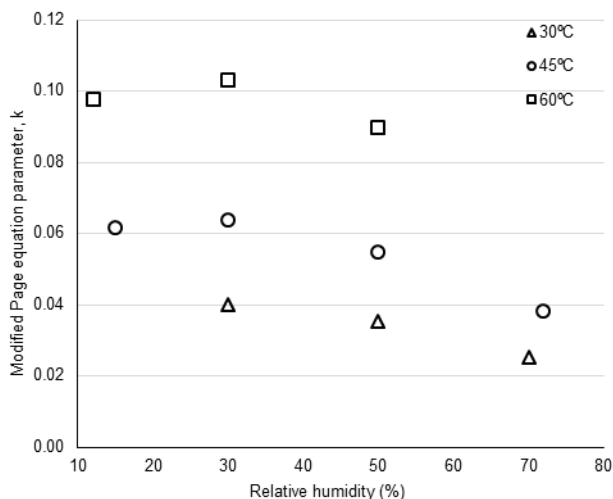

Figure 6. Relationship between the modified Page equation parameter k (eq. 6) and drying air RH for three drying air temperatures.

where T ($^{\circ}\text{C}$) is the temperature and RH (%) is the relative humidity of the drying air. When applying these parameters in the thin-layer drying equations (eqs. 3 and 6), the drying duration (t) should be expressed in min. The R^2 values suggest that equations 7 and 8 could both be satisfactorily used to determine the parameters of the corresponding thin-layer drying equations, within the tested range of drying air conditions; between the two, the modified Page equation was determined to be slightly more accurate. Development of equations 7 and 8 allows an accurate mathematical description of thin-layer drying of rice.

IMPACT OF HARVEST MOISTURE CONTENT OF RICE ON DRYING PARAMETERS

Thin-layer drying runs of two ‘Roy J’ and three ‘XP753’ cultivar lots were performed to explore whether harvest MC had an impact on the drying rate. The modified Page equation parameter was used to compare the impact of harvest MC for each cultivar. In general, drying parameter k , which indicates the trend in the drying rate, slightly declined with a decrease in harvest MC (fig. 7). Such a trend could be explained by considering the energy requirement for moisture transport, which becomes greater at lower MCs as water

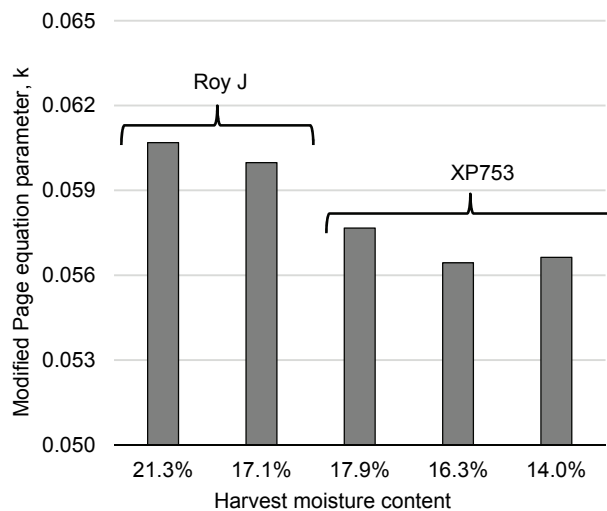

Figure 7. Impact of harvest moisture content (% w.b.) on drying parameter k of the modified Page equation (eq. 6) for two ‘Roy J’ and three ‘XP753’ rice lots (table 2). Air conditions for the drying runs were 45°C and 30% RH.

molecules are more firmly bound (Elbert et al., 2001; Billiris et al. 2011). However, the magnitude of the difference in drying parameter k was less than 0.0013 units for each cultivar. Because the variability within individual cultivars was less than the standard error obtained in the regression equation (eq. 7), the impact of harvest MC was deemed negligible.

VALIDITY OF DEVELOPED EQUATIONS FOR POPULAR RICE CULTIVARS

Equations 7 and 8, which describe the effect of drying air conditions on the drying parameters of the modified Page and infinite-series diffusion equations, respectively, were determined based on drying runs using the rice cultivar ‘Roy J’. It was deemed important to test the validity of these equations for other popular rice cultivars. Figure 8 shows a comparison between experimental drying curves for five other long-grain rice cultivars and the predicted drying curve using the infinite-series diffusion equation (eq. 3) with drying parameter k estimated by equation 8. The maximum differ-

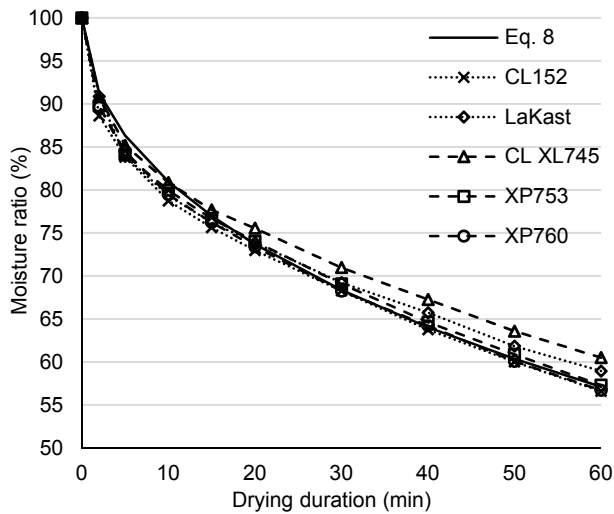

Figure 8. Comparison between experimental thin-layer drying curves of five long-grain rice cultivars and the corresponding predicted drying curve using the infinite-series diffusion equation parameter k determined by equation 8 when the drying air was at 45°C and 30% RH.

ence between the equation-predicted and experimentally measured MR was 3.4 percentage points; a slightly lesser maximum difference of 2.9 percentage points was obtained when the modified Page equation was used to predict the drying curve. The small difference between the drying characteristics of these cultivars could be explained based on the inherent biological variations in shape, size, morphology, and composition of their kernels.

Another consideration in regard to possible drying differences among cultivars is that hybrid rice cultivars are morphologically distinct from pure-line cultivars due to the presence of hair-like microstructures (sometimes referred as “pubescence”) on the hulls (Atungulu et al., 2015). Such pubescence has been speculated to affect rice drying by providing a larger surface area. However, a comparison of the drying parameters obtained from drying runs performed at 45°C and 30% RH air conditions showed that no clear trend existed between the pure-line and hybrid cultivars (fig. 9). In

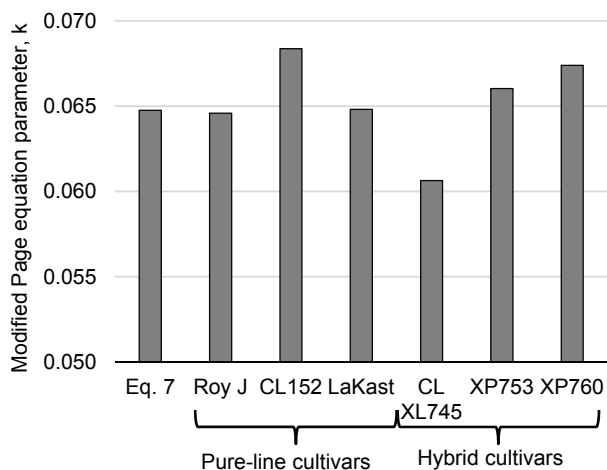

Figure 9. Comparison of drying parameters of the modified Page equation (eq. 6) for the indicated pure-line and hybrids cultivars (table 2), when the drying air was 45°C and 30% RH. The drying parameter predicted by the regression equation (eq. 7) is shown for reference.

fact, the difference in drying parameter k for cultivars within the pure-line or hybrid groups was more substantial than the difference between these groups. Thus, it could not be ascertained whether the impact of pubescence exceeds the impact of other biological factors mentioned above on the drying characteristics of cultivars. Hybrid rice cultivars are also generally observed to have lesser bulk densities, which may affect drying in a deep bed; however, quantifying the impact of such differences is beyond the scope of thin-layer drying experiments.

CONCLUSIONS

Thin-layer drying runs were performed for a popular long-grain rice cultivar (‘Roy J’) under 18 drying air conditions that are typically observed in on-farm and industrial-scale rice dryers. The drying curves for 30% RH conditions were very close to drying conditions at 50% RH; however, 70% RH typically produced much slower drying of rice kernels. In general, the rice drying rates increased with an increase in air temperature and a decrease in air RH. These experiments provide fundamental drying data for contemporary rice cultivars grown in the Mid-South U.S.

Two single-parameter equations (modified Page equation and infinite-series diffusion equation) were proposed to quantify the thin-layer experimental data. In contrast to previously reported diffusion equations, several higher-order terms of the infinite series were considered in this study; this approach resulted in a better fit to the experimental data as well as producing a single-parameter diffusion equation. The Page model was modified using a fixed value for its n parameter. The proposed single-parameter equations described the drying data more accurately than the Newton equation; the RMSEs in MRs obtained for the modified Page, infinite-series diffusion, and Newton equations varied in the ranges of 0.2 to 1.4, 0.3 to 1.5, and 1.6 to 8.0 percentage points, respectively. Development of accurate single-parameter drying equations makes it possible to compare and quantify the impact of drying air temperature, RH, or other factors on the drying characteristics of rice.

Second-order polynomial regression equations were developed to accurately describe the dependence of drying air temperature and RH on the drying parameters of the modified Page and infinite-series diffusion equations. Development of these equations allows an accurate mathematical description of thin-layer drying of rice. Incorporation of these equations into deep-bed drying models is expected to improve model predictions and thus facilitate optimization of commercial drying operations.

The impact of harvest MC on the drying characteristics of rice was observed to be negligible for each tested rice cultivar; drying parameter k of the modified Page equation differed by less than 0.0013 units between rice lots having different harvest MCs in the 14% to 21% range. The validity of the proposed single-parameter drying equations was also evaluated for five additional long-grain rice cultivars; for these cultivars, the maximum errors in MR prediction by the infinite-series diffusion and modified Page equations were 3.4 and 2.9 percentage points, respectively. When drying pa-

rameters of pure-line and hybrid rice cultivars were compared, no specific trend was observed to indicate the role of “pubescence” in the hybrid cultivars. While the proposed single-parameter equations were tested only for long-grain rice, the methodology presented in this research could be used to develop similar single-parameter thin-layer drying equations for short-grain and medium-grain rice, as well as other agricultural crops.

ACKNOWLEDGEMENTS

The authors acknowledge the financial support by the corporate sponsors of the University of Arkansas Rice Processing Program and the Arkansas Rice Research and Promotion Board.

REFERENCES

- Agrawal, Y. C., & Singh, R. P. (1977). Thin-layer drying studies on short-grain rough rice. ASAE Paper No. 773531. St. Joseph, MI: ASAE.
- Allen, J. R. (1960). Application of grain drying theory to the drying of maize and rice. *J. Agric. Eng. Res.*, 5(4), 363-385.
- ASABE. (2014). ANSI/ASAE S448.2: Thin-layer drying of agricultural crops. St. Joseph, MI: ASABE.
- Atungulu, G. G., Zhong, H., Thote, S., Okeyo, A., & Couch, A. (2015). Microbial prevalence on freshly harvested long-grain pureline, hybrid, and medium-grain rice cultivars. *Appl. Eng. Agric.*, 31(6), 949-956. <https://doi.org/10.13031/aea.31.11216>
- Banaszek, M. M., & Siebenmorgen, T. J. (1990). Adsorption equilibrium moisture contents of long-grain rough rice. *Trans. ASAE*, 33(1), 247-252. <https://doi.org/10.13031/2013.31323>
- Billiris, M. A., Siebenmorgen, T. J., & Mauromoustakos, A. (2011). Estimating the theoretical energy required to dry rice. *J. Food Eng.*, 107(2), 253-261. <https://doi.org/10.1016/j.jfoodeng.2011.06.015>
- Bingol, G., Prakash, B., & Pan, Z. (2012). Dynamic vapor sorption isotherms of medium-grain rice varieties. *LWT - Food Sci. Tech.*, 48(2), 156-163. <https://doi.org/10.1016/j.lwt.2012.02.026>
- Brooker, D. B., Bakker-Arkema, F. W., & Hall, C. W. (1992). *Drying and storage of grains and oilseeds*. New York, NY: Van Nostrand Reinhold.
- Cnossen, A. G., & Siebenmorgen, T. J. (2000). The glass transition temperature concept in rice drying and tempering: Effect on milling quality. *Trans. ASAE*, 43(6), 1661-1667. <https://doi.org/10.13031/2013.3066>
- Cnossen, A. G., Siebenmorgen, T. J., & Yang, W. (2002). The glass transition temperature concept in rice drying and tempering: Effect on drying rate. *Trans. ASAE*, 45(3), 759-766. <https://doi.org/10.13031/2013.8845>
- Crank, J. (1975). *The mathematics of diffusion*. London, UK: Oxford University Press.
- Elbert, G., Tolaba, M. P., Aguerre, R. J., & Suarez, C. (2001). A diffusion model with a moisture-dependent diffusion coefficient for parboiled rice. *Drying Tech.*, 19(1), 155-166. <https://doi.org/10.1081/DRT-100001358>
- Hacihafizoglu, O., Cihan, A., & Kahveci, K. (2008). Mathematical modeling of drying thin-layer rough rice. *Food Bioprod. Proc.*, 86(4), 268-275. <https://doi.org/10.1016/j.fbp.2008.01.002>
- Henderson, S. M. (1974). Progress in developing the thin-layer drying equation. *Trans. ASAE*, 17(6), 1167-1168, 1172. <https://doi.org/10.13031/2013.37052>
- Henderson, S. M., & Pabis, S. (1961). Grain drying theory: I. Temperature effect on drying coefficient. *J. Agric. Eng. Res.*, 6(3), 169-174.
- Jayas, D. S. (1991). Review of thin-layer drying and wetting equations. *Drying Tech.*, 9(3), 551-558. <https://doi.org/10.1080/07373939108916697>
- Jindal, V. K., & Siebenmorgen, T. J. (1987). Effects of oven drying temperature and drying time on rough rice moisture content determination. *Trans. ASAE*, 30(4), 1185-1192. <https://doi.org/10.13031/2013.30542>
- Kachru, R. P., Ojha, T. P., & Kurup, G. T. (1970). Drying characteristics of Indian paddy varieties. *J. Agric. Eng.*, 8(1), 16-23.
- Kucuk, H., Midilli, A., Kilic, A., & Dincer, I. (2014). A review on thin-layer drying curve equations. *Drying Tech.*, 32(7), 757-773. <https://doi.org/10.1080/07373937.2013.873047>
- Lu, R., & Siebenmorgen, T. J. (1992). Moisture diffusivity of long-grain rice components. *Trans. ASAE*, 35(6), 1955-1961. <https://doi.org/10.13031/2013.28822>
- Midilli, A., Kucuk, H., & Yaper, Z. (2002). A new model for single-layer drying. *Drying Tech.*, 20(7), 1503-1513. <https://doi.org/10.1081/DRT-120005864>
- Ondier, G. O., Siebenmorgen, T. J., & Mauromoustakos, A. (2010). Equilibrium moisture contents of rough rice dried using high-temperature, fluidized-bed conditions. *Trans. ASABE*, 53(5), 1667-1672. <https://doi.org/10.13031/2013.34885>
- Ondier, G. O., Siebenmorgen, T. J., Bautista, R. C., & Mauromoustakos, A. (2011). Equilibrium moisture contents of pureline, hybrid, and parboiled rice. *Trans. ASABE*, 54(3), 1007-1013. <https://doi.org/10.13031/2013.37085>
- Page, G. E. (1949). Factors influencing the maximum rates of air drying shelled corn in thin layers. MS thesis. West Lafayette, IN: Purdue University.
- Prakash, B. (2011). Mathematical modeling of moisture movement within a rice kernel during convective and infrared drying. PhD diss. Davis, CA: University of California.
- Prakash, B., & Pan, Z. (2011). Chapter 14: Modeling moisture movement in rice. In M. El-Amin (Ed.), *Advance topics in mass transfer* (pp. 283-304). Rijeka, Croatia: InTech.
- Prakash, B., & Pan, Z. (2012). Effect of geometry of rice kernels on drying modeling results. *Drying Tech.*, 30(8), 801-807. <https://doi.org/10.1080/07373937.2012.665112>
- Prakash, B., Bingol, G., & Pan, Z. (2011). Moisture diffusivity in rice components during absorption and desorption. *Drying Tech.*, 29(8), 939-945. <https://doi.org/10.1080/07373937.2011.561942>
- Prakash, B., Mukhopadhyay, S., & Siebenmorgen, T. J. (2017). Mathematical modeling of a cross-flow rice dryer. *Trans. ASABE*, 60(3), 999-1009. <https://doi.org/10.13031/trans.12155>
- Steffe, J. F., & Singh, R. P. (1980). Liquid diffusivity of rough rice components. *Trans. ASAE*, 23(3), 767-774, 782. <https://doi.org/10.13031/2013.34660>
- Verma, L. R., Bucklin, R. A., Endan, J. B., & Wratten, F. T. (1985). Effects of drying air parameters on rice drying models. *Trans. ASAE*, 28(1), 296-301. <https://doi.org/10.13031/2013.32245>

APPENDIX
THIN-LAYER DRYING DATA AND EQUATION
PARAMETERS FOR 18 DRYING CONDITIONS

	Drying Condition Number																	
	1	2	3	4	5	6	7	8	9	10	11	12	13	14	15	16	17	18
Drying air and grain conditions																		
Air temp. (°C)	20	20	30	30	30	37.5	37.5	37.5	45	45	45	45	52.5	52.5	52.5	60	60	60
Air RH (%)	50	70	30	50	70	30	50	70	15	30	50	72	30	50	72	12	30	50
Rice initial MC (% w.b.)	21.2	21.2	18.8	18.8	18.8	18.2	18.2	18.2	18.8	18.8	18.8	18.8	18.2	18.2	18.2	18.8	18.6	18.6
Rice EMC (% w.b.) ^[a]	11.0	13.2	8.3	10.3	12.5	7.8	9.8	12.1	5.7	7.4	9.4	12.0	7.0	9.0	11.6	4.4	6.6	8.7
Thin-layer drying run data																		
Duration	Moisture Ratio (%) ^[b]																	
2 min	96.9	98.5	94.6	95.4	96.9	92.7	94.1	95.3	91.4	91.5	94.0 ^[c]	97.8	89.6	91.4	93.3 ^[c]	86.7	86.8	90.0
5 min	94.2	97.1	90.3	92.3	94.2	87.5	89.2	92.0	85.9	84.8	88.1 ^[c]	90.3	82.0	84.1	87.8	79.2	79.1	81.9
10 min	91.5	95.4	86.0	88.0	92.0	82.5	84.4	88.6	80.4	79.5	82.7 ^[c]	86.4	76.3	77.4	82.2	73.0	72.4	75.8
15 min	89.6	94.2	83.7	85.9	90.3	79.5	81.4	85.5	77.2	76.3	79.5 ^[c]	83.9	72.4	74.1	78.9	68.3	67.2	70.7
20 min	87.8	93.0	81.5	83.9	88.6	77.5	79.0	82.5	74.0	73.8	77.1 ^[c]	82.9	69.3	70.5	76.7	64.2	62.7	66.5
30 min	85.5	91.3	78.6	80.8	86.1	74.1	75.6	79.7	70.3	69.2	72.4 ^[c]	79.9	62.4	64.3	72.0	56.8	54.9	59.3
40 min	84.0	89.9	76.8	78.9	84.1	70.6	72.9	78.1	66.4	65.4	69.2 ^[c]	77.9	57.4	59.4	67.6	51.2	48.8	54.0
50 min	82.4	88.7	74.6	77.1	82.4	68.1	70.2	75.3	63.0	62.0	65.8 ^[c]	75.3	52.4	55.5	64.5	46.6	44.5	48.9
60 min	81.3	87.6	73.1	75.0	80.9	65.6	67.8	72.8	59.8	58.8	62.9 ^[c]	72.8	48.7	50.9	61.5	42.9	39.9	44.5
Thin-layer drying equations: parameters and RMSEs in MR predictions																		
Newton equation (table 1)																		
$k \times 1000$	4.32	2.59	6.73	5.96	4.26	8.92	8.12	6.42	10.73	11.15	9.54	6.50	14.84	13.72	9.98	18.03	19.32	16.54
RMSE	3.3	1.6	5.3	4.3	2.9	6.2	5.5	4.2	6.6	6.9	5.6	4.8	7.0	6.5	5.6	8.0	7.7	6.7
Infinite-series diffusion equation (eq. 3)																		
$k \times 1,000,000$	1.03	0.38	2.35	1.87	0.99	3.86	3.26	2.11	5.26	5.62	4.27	2.18	8.87	7.79	4.60	12.02	13.28	10.44
RMSE	0.5	0.5	1.2	0.7	0.3	1.1	0.8	0.6	0.9	1.1	0.7	1.5	0.7	0.7	0.5	0.7	0.4	0.8
Page equation (table 1)																		
$k \times 1000$	28.3	12.1	51.5	39.7	24.8	63.3	53.1	37.6	68.4	72.1	53.7	42.0	75.4	67.0	54.7	92.3	89.4	71.8
n	0.49	0.59	0.45	0.49	0.53	0.46	0.49	0.52	0.49	0.48	0.53	0.49	0.54	0.56	0.53	0.54	0.56	0.59
RMSE	0.4	0.1	0.6	0.5	0.2	0.5	0.6	0.5	0.4	0.5	0.6	1.4	0.8	0.6	0.5	0.7	0.7	0.6
Modified Page equation (eq. 6)																		
$k \times 1000$	25.8	15.4	39.9	35.3	25.3	52.0	47.4	37.7	61.5	63.8	54.9	38.3	82.1	76.3	57.1	97.5	103.2	89.8
RMSE	0.5	0.4	1.1	0.6	0.2	1.0	0.7	0.5	0.7	0.8	0.6	1.4	0.9	1.0	0.5	0.8	1.2	1.4

^[a] Rice EMC corresponding to a specific drying condition was determined using modified Chung-Pfost equation (eq. 4) with parameters from Ondier et al. (2011).

^[b] Each reported MR value is an average of the two MRs obtained from duplicate drying runs, except the observations with superscript [c].

^[c] Reported MR value is obtained from a single drying run.